

Ultrafast recovery diode

Main product characteristics

| | |
|----------------------|--------|
| $I_{F(AV)}$ | 15 A |
| V_{RRM} | 200 V |
| $T_j(\text{max})$ | 175° C |
| $V_F(\text{typ})$ | 0.85 V |
| $t_{rr}(\text{typ})$ | 20 ns |

Features and benefits

- Very low conduction losses
- Negligible switching losses
- Low forward and reverse recovery time
- High junction temperature
- Insulated packages
 - TO-220FPAC
Electrical insulation 2000 V_{DC}
 - TO-220AC Ins
Electrical insulation 2500 V_{RMS}

Description

The STTH1502 uses ST's new 200V planar Pt doping technology, and is specially suited for switching mode base drive and transistor circuits.

Packaged in TO-220AC, TO-220FPAC, and TO-220 Ins, this device is intended for use in low voltage, high frequency inverters, free wheeling and polarity protection.

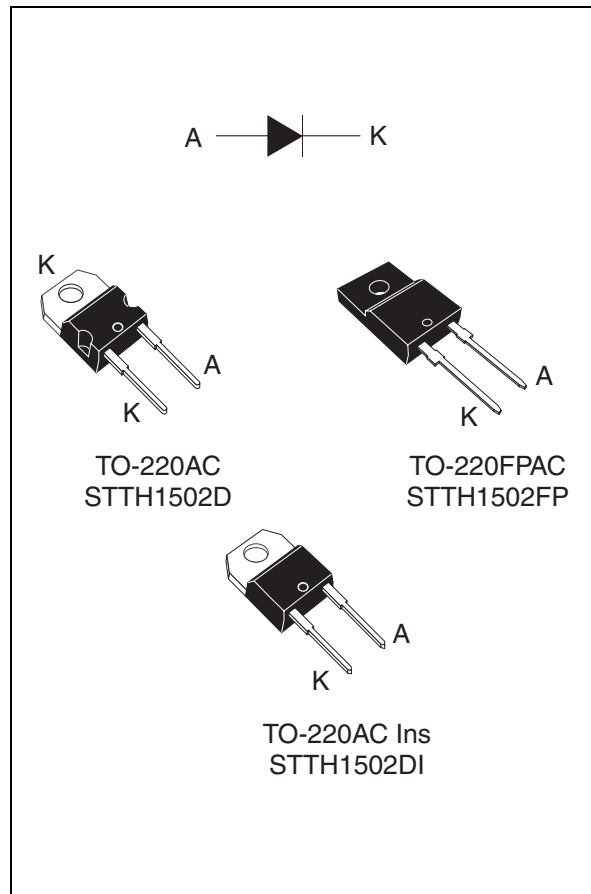

Order codes

| Part Number | Marking |
|-------------|------------|
| STTH1502D | STTH1502 |
| STTH1502FP | STTH1502 |
| STTH1502DI | STTH1502DI |

1 Characteristics

Table 1. Absolute ratings (limiting values at $T_j = 25^\circ\text{C}$, unless otherwise specified)

| Symbol | Parameter | | Value | Unit | |
|--------------|---|---------------------------------|---------------------------|------------------|---|
| V_{RRM} | Repetitive peak reverse voltage | | 200 | V | |
| $I_{F(RMS)}$ | RMS forward current | | 32 | A | |
| $I_{F(AV)}$ | Average forward current, $\delta = 0.5$ | TO-220AC | $T_c = 130^\circ\text{C}$ | 15 | A |
| | | TO-220AC Ins | $T_c = 105^\circ\text{C}$ | | |
| | | TO-220FPAC | $T_c = 85^\circ\text{C}$ | | |
| I_{FSM} | Surge non repetitive forward current | $t_p = 10\text{ ms}$ Sinusoidal | 150 | A | |
| T_{stg} | Storage temperature range | | -65 to + 175 | $^\circ\text{C}$ | |
| T_j | Maximum operating junction temperature | | 175 | $^\circ\text{C}$ | |

Table 2. Thermal parameters

| Symbol | Parameter | | Value | Unit |
|---------------|------------------|--------------|-------|--------------------|
| $R_{th(j-c)}$ | Junction to case | TO-220AC | 2.5 | $^\circ\text{C/W}$ |
| | | TO-220AC Ins | 3.8 | |
| | | TO-220FPAC | 5 | |

Table 3. Static electrical characteristics

| Symbol | Parameter | Test conditions | | Min. | Typ | Max. | Unit |
|-------------|-------------------------|---------------------------|---------------------|------|------|------|---------------|
| $I_R^{(1)}$ | Reverse leakage current | $T_j = 25^\circ\text{C}$ | $V_R = V_{RRM}$ | | | 10 | μA |
| | | $T_j = 125^\circ\text{C}$ | | | 10 | 100 | |
| $V_F^{(2)}$ | Forward voltage drop | $T_j = 25^\circ\text{C}$ | $I_F = 15\text{ A}$ | | 1 | 1.1 | V |
| | | $T_j = 150^\circ\text{C}$ | | | 0.85 | 0.95 | |
| | | $T_j = 125^\circ\text{C}$ | $I_F = 30\text{ A}$ | | 1.05 | 1.20 | |
| | | $T_j = 25^\circ\text{C}$ | | | 1.15 | 1.3 | |
| | | $T_j = 150^\circ\text{C}$ | | | 1 | 1.15 | |

1. Pulse test: $t_p = 5\text{ ms}$, $\delta < 2\%$

2. Pulse test: $t_p = 380\text{ }\mu\text{s}$, $\delta < 2\%$

To evaluate the conduction losses use the following equation:

$$P = 0.74 \times I_{F(AV)} + 0.014 I_{F(RMS)}^2$$

Table 4. Dynamic characteristics

| Symbol | Parameter | Test conditions | Min. | Typ | Max. | Unit |
|----------|--------------------------|---|------|-----|------|------|
| t_{rr} | Reverse recovery time | $I_F = 1\text{ A}$, $di_F/dt = -50\text{ A}/\mu\text{s}$, $V_R = 30\text{ V}$, $T_j = 25^\circ\text{ C}$ | | 28 | 36 | ns |
| | | $I_F = 1\text{ A}$, $di_F/dt = -100\text{ A}/\mu\text{s}$, $V_R = 30\text{ V}$, $T_j = 25^\circ\text{ C}$ | | 20 | 25 | |
| I_{RM} | Reverse recovery current | $I_F = 15\text{ A}$, $di_F/dt = -200\text{ A}/\mu\text{s}$, $V_R = 160\text{ V}$, $T_j = 125^\circ\text{ C}$ | | 5.7 | 7.2 | A |
| t_{fr} | Forward recovery time | $I_F = 15\text{ A}$, $di_F/dt = 50\text{ A}/\mu\text{s}$ $V_{FR} = 1.1 \times V_{Fmax}$, $T_j = 25^\circ\text{ C}$ | | 200 | | ns |
| V_{FP} | Forward recovery voltage | $I_F = 15\text{ A}$, $di_F/dt = 50\text{ A}/\mu\text{s}$, $T_j = 25^\circ\text{ C}$ | | 1.3 | | V |

Figure 1. Peak current versus duty cycle

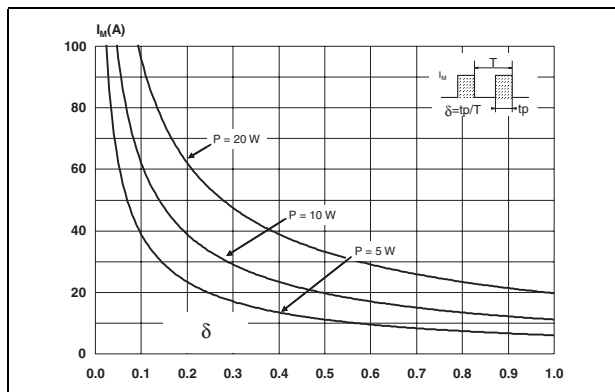

Figure 2. Forward voltage drop versus forward current (typical values)

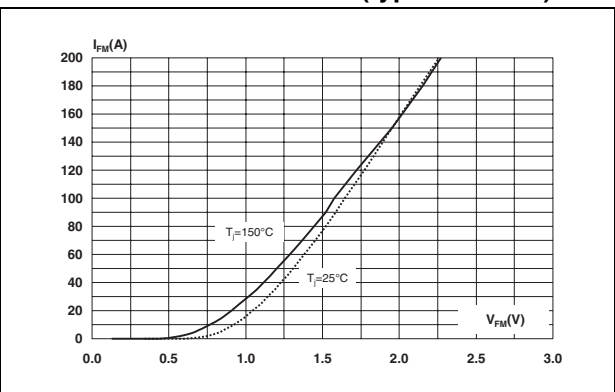

Figure 3. Forward voltage drop versus forward current (maximum values)

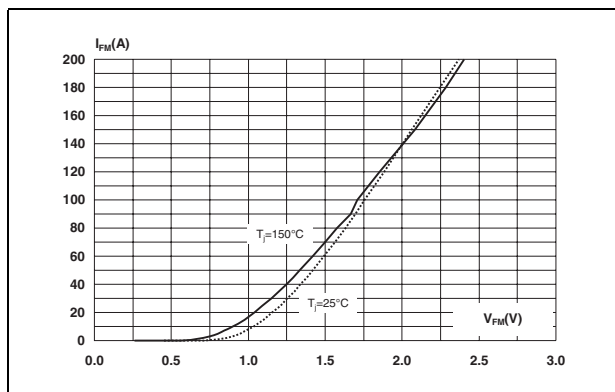

Figure 4. Relative variation of thermal impedance, junction to case, versus pulse duration (TO-220AC)

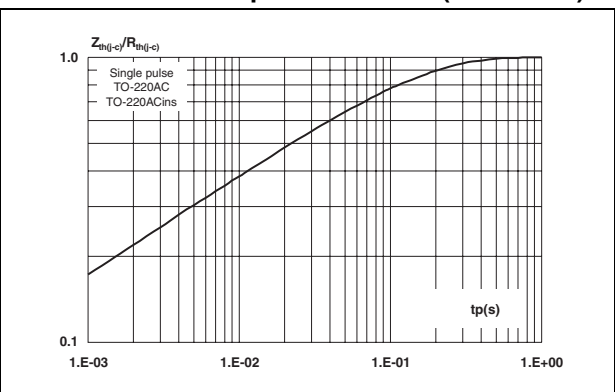

Figure 5. Relative variation of thermal impedance, junction to case, versus pulse duration (TO-220FPAC)

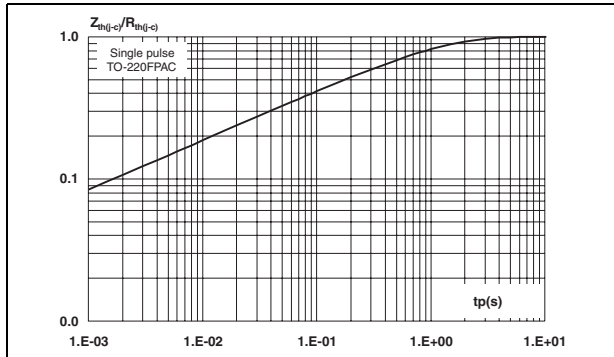

Figure 6. Junction capacitance versus reverse applied voltage (typical values)

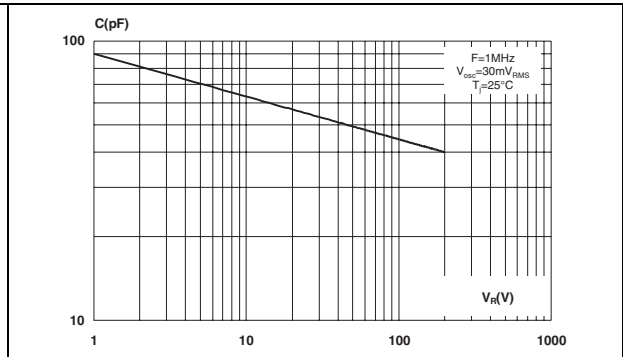

Figure 7. Reverse recovery charges versus di_F/dt (typical values)

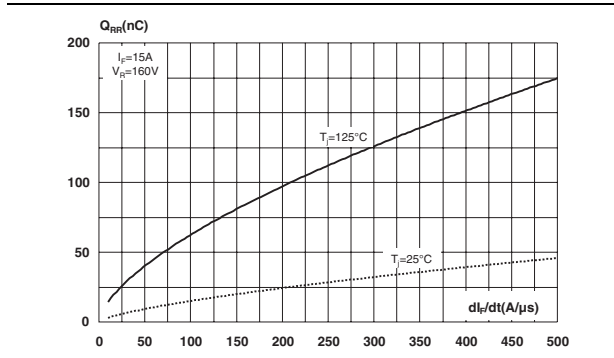

Figure 8. Reverse recovery time versus di_F/dt (typical values)

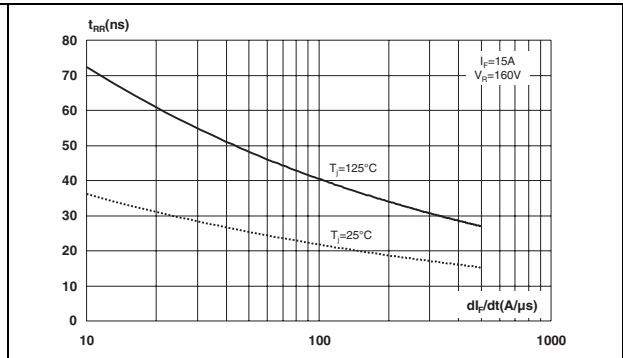

Figure 9. Peak reverse recovery current versus di_F/dt (typical values)

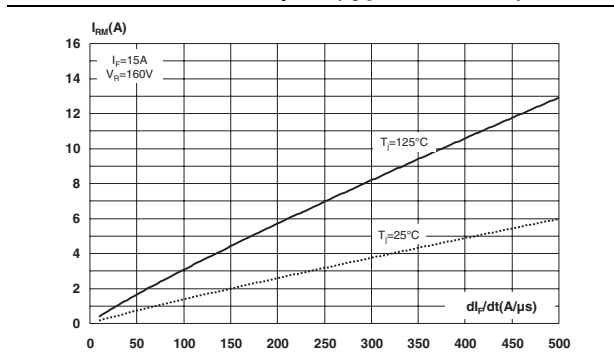
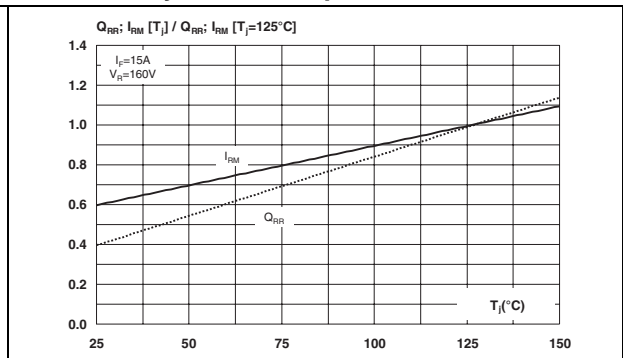
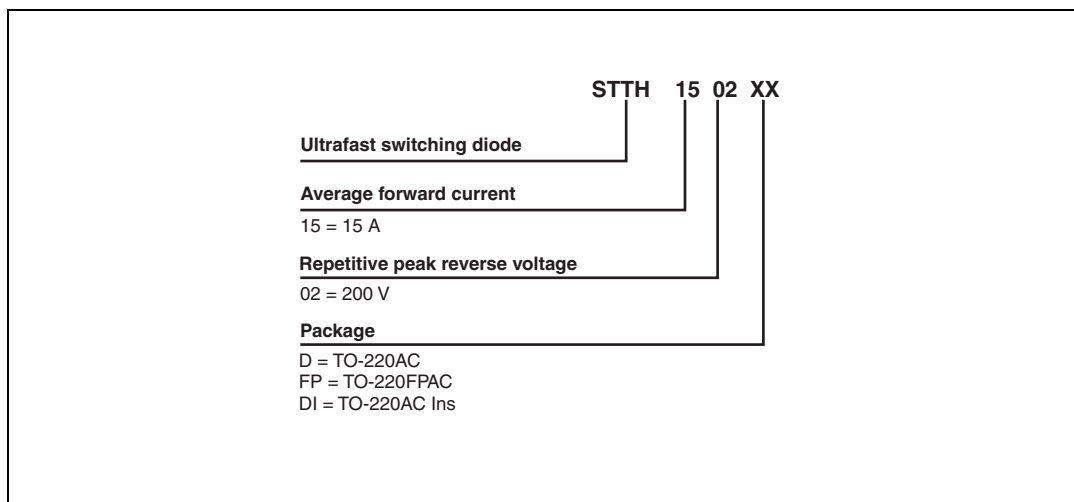

Figure 10. Dynamic parameters versus junction temperature



2 Ordering information scheme



3 Package information

Epoxy meets UL94, V0

Cooling method: by conduction (C)

Recommended torque value: 0.8 Nm

Maximum torque value: 1.0 Nm

Table 5. T0-220AC dimensions

| REF. | DIMENSIONS | | | |
|---------|-------------|-------|------------|-------|
| | Millimeters | | Inches | |
| | Min. | Max. | Min. | Max. |
| A | 4.40 | 4.60 | 0.173 | 0.181 |
| C | 1.23 | 1.32 | 0.048 | 0.051 |
| D | 2.40 | 2.72 | 0.094 | 0.107 |
| E | 0.49 | 0.70 | 0.019 | 0.027 |
| F | 0.61 | 0.88 | 0.024 | 0.034 |
| F1 | 1.14 | 1.70 | 0.044 | 0.066 |
| G | 4.95 | 5.15 | 0.194 | 0.202 |
| H2 | 10.00 | 10.40 | 0.393 | 0.409 |
| L2 | 16.40 typ. | | 0.645 typ. | |
| L4 | 13.00 | 14.00 | 0.511 | 0.551 |
| L5 | 2.65 | 2.95 | 0.104 | 0.116 |
| L6 | 15.25 | 15.75 | 0.600 | 0.620 |
| L7 | 6.20 | 6.60 | 0.244 | 0.259 |
| L9 | 3.50 | 3.93 | 0.137 | 0.154 |
| M | 2.6 typ. | | 0.102 typ. | |
| Diam. I | 3.75 | 3.85 | 0.147 | 0.151 |

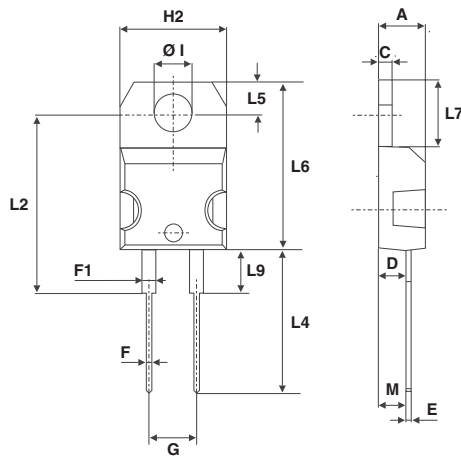
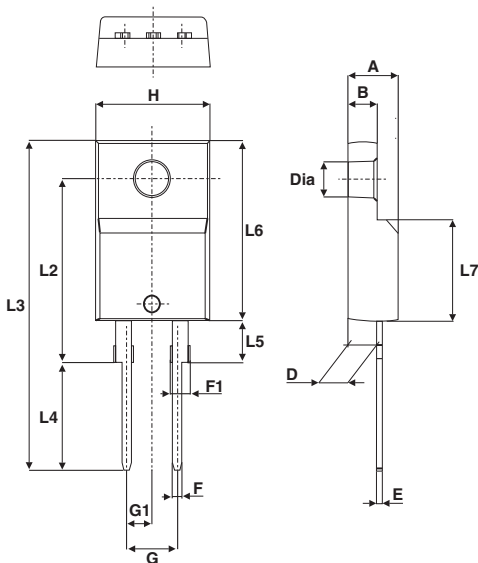
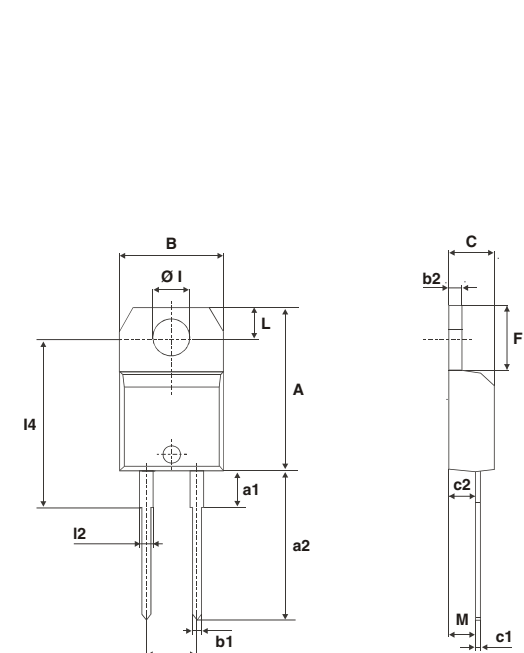

Table 6. T0-220FPAC dimensions



| REF | DIMENSIONS | | | |
|------|-------------|------|-----------|-------|
| | Millimeters | | Inches | |
| | Min. | Max. | Min. | Max. |
| A | 4.4 | 4.6 | 0.173 | 0.181 |
| B | 2.5 | 2.7 | 0.098 | 0.106 |
| D | 2.5 | 2.75 | 0.098 | 0.108 |
| E | 0.45 | 0.70 | 0.018 | 0.027 |
| F | 0.75 | 1 | 0.030 | 0.039 |
| F1 | 1.15 | 1.70 | 0.045 | 0.067 |
| G | 4.95 | 5.20 | 0.195 | 0.205 |
| G1 | 2.4 | 2.7 | 0.094 | 0.106 |
| H | 10 | 10.4 | 0.393 | 0.409 |
| L2 | 16 Typ. | | 0.63 Typ. | |
| L3 | 28.6 | 30.6 | 1.126 | 1.205 |
| L4 | 9.8 | 10.6 | 0.386 | 0.417 |
| L5 | 2.9 | 3.6 | 0.114 | 0.142 |
| L6 | 15.9 | 16.4 | 0.626 | 0.646 |
| L7 | 9.00 | 9.30 | 0.354 | 0.366 |
| Dia. | 3.00 | 3.20 | 0.118 | 0.126 |

Table 7. TO-220AC Ins. dimensions



| Ref. | Dimensions | | | | | |
|------|-------------|-------|-------|--------|-------|-------|
| | Millimeters | | | Inches | | |
| | Min. | Typ. | Max. | Min. | Typ. | Max. |
| A | 15.20 | | 15.90 | 0.598 | | 0.625 |
| a1 | | 3.75 | | | 0.147 | |
| a2 | 13.00 | | 14.00 | 0.511 | | 0.551 |
| B | 10.00 | | 10.40 | 0.393 | | 0.409 |
| b1 | 0.61 | | 0.88 | 0.024 | | 0.034 |
| b2 | 1.23 | | 1.32 | 0.048 | | 0.051 |
| C | 4.40 | | 4.60 | 0.173 | | 0.181 |
| c1 | 0.49 | | 0.70 | 0.019 | | 0.027 |
| c2 | 2.40 | | 2.72 | 0.094 | | 0.107 |
| e | 4.80 | | 5.40 | 0.189 | | 0.212 |
| F | 6.20 | | 6.60 | 0.244 | | 0.259 |
| ØI | 3.75 | | 3.85 | 0.147 | | 0.151 |
| I4 | 15.80 | 16.40 | 16.80 | 0.622 | 0.646 | 0.661 |
| L | 2.65 | | 2.95 | 0.104 | | 0.116 |
| I2 | 1.14 | | 1.70 | 0.044 | | 0.066 |
| M | | 2.60 | | | 0.102 | |

In order to meet environmental requirements, ST offers these devices in ECOPACK® packages. These packages have a lead-free second level interconnect. The category of second level interconnect is marked on the package and on the inner box label, in compliance with JEDEC Standard JESD97. The maximum ratings related to soldering conditions are also marked on the inner box label. ECOPACK is an ST trademark. ECOPACK specifications are available at: www.st.com.

4 Ordering information

| Part Number | Marking | Package | Weight | Base qty | Delivery mode |
|-------------|------------|--------------|--------|----------|---------------|
| STTH1502D | STTH1502 | TO-220AC | 1.86 g | 50 | Tube |
| STTH1502FP | STTH1502 | TO-220FPAC | 2.2 g | 50 | Tube |
| STTH1502DI | STTH1502DI | TO-220AC Ins | 1.86 | 50 | Tube |

5 Revision history

| Date | Revision | Description of Changes |
|-------------|----------|----------------------------|
| 05-Apr-2006 | 1 | First issue |
| 10-Oct-2006 | 2 | Added TO-220AC Ins package |

Please Read Carefully:

Information in this document is provided solely in connection with ST products. STMicroelectronics NV and its subsidiaries ("ST") reserve the right to make changes, corrections, modifications or improvements, to this document, and the products and services described herein at any time, without notice.

All ST products are sold pursuant to ST's terms and conditions of sale.

Purchasers are solely responsible for the choice, selection and use of the ST products and services described herein, and ST assumes no liability whatsoever relating to the choice, selection or use of the ST products and services described herein.

No license, express or implied, by estoppel or otherwise, to any intellectual property rights is granted under this document. If any part of this document refers to any third party products or services it shall not be deemed a license grant by ST for the use of such third party products or services, or any intellectual property contained therein or considered as a warranty covering the use in any manner whatsoever of such third party products or services or any intellectual property contained therein.

UNLESS OTHERWISE SET FORTH IN ST'S TERMS AND CONDITIONS OF SALE ST DISCLAIMS ANY EXPRESS OR IMPLIED WARRANTY WITH RESPECT TO THE USE AND/OR SALE OF ST PRODUCTS INCLUDING WITHOUT LIMITATION IMPLIED WARRANTIES OF MERCHANTABILITY, FITNESS FOR A PARTICULAR PURPOSE (AND THEIR EQUIVALENTS UNDER THE LAWS OF ANY JURISDICTION), OR INFRINGEMENT OF ANY PATENT, COPYRIGHT OR OTHER INTELLECTUAL PROPERTY RIGHT.

UNLESS EXPRESSLY APPROVED IN WRITING BY AN AUTHORIZED ST REPRESENTATIVE, ST PRODUCTS ARE NOT RECOMMENDED, AUTHORIZED OR WARRANTED FOR USE IN MILITARY, AIR CRAFT, SPACE, LIFE SAVING, OR LIFE SUSTAINING APPLICATIONS, NOR IN PRODUCTS OR SYSTEMS WHERE FAILURE OR MALFUNCTION MAY RESULT IN PERSONAL INJURY, DEATH, OR SEVERE PROPERTY OR ENVIRONMENTAL DAMAGE. ST PRODUCTS WHICH ARE NOT SPECIFIED AS "AUTOMOTIVE GRADE" MAY ONLY BE USED IN AUTOMOTIVE APPLICATIONS AT USER'S OWN RISK.

Resale of ST products with provisions different from the statements and/or technical features set forth in this document shall immediately void any warranty granted by ST for the ST product or service described herein and shall not create or extend in any manner whatsoever, any liability of ST.

ST and the ST logo are trademarks or registered trademarks of ST in various countries.

Information in this document supersedes and replaces all information previously supplied.

The ST logo is a registered trademark of STMicroelectronics. All other names are the property of their respective owners.

© 2006 STMicroelectronics - All rights reserved

STMicroelectronics group of companies

Australia - Belgium - Brazil - Canada - China - Czech Republic - Finland - France - Germany - Hong Kong - India - Israel - Italy - Japan - Malaysia - Malta - Morocco - Singapore - Spain - Sweden - Switzerland - United Kingdom - United States of America

www.st.com